

# **THERMOPLASTIC IN SITU PLACEMENT REQUIRES BETTER IMPREGNATED TAPES AND TOWS**

Mark B. Gruber, Ira Z. Lockwood, Tracy L. Dolan, Steven B. Funck  
Accudyne Systems, Inc., 210 Executive Drive, Suite 5  
Newark, DE 19702, USA

John J. Tierney, Pavel Simacek, John W. Gillespie, Jr., Suresh G. Advani  
University of Delaware Center for Composite Materials  
Newark DE, 19716, USA

Brian J. Jensen, Roberto J. Cano, Brian W. Grimsley  
NASA Langley Research Center, Hampton, VA, 23681, USA

## **ABSTRACT**

Current commercially available thermoplastic impregnated tapes were not developed for in situ processing. Consequently, thermoplastic automated tape placement is limited in generating autoclave-level properties required for commercial adoption in wing and fuselage skins and tanks unless 1) the tape quality improves significantly, 2) the deposition head places at a snail's pace, or 3) the head process length grows exceedingly long. Economics precludes the second choice; machine operability the third. Under NASA sponsorship, Accudyne and the University of Delaware completed a comprehensive study of the physical mechanisms controlling laminate quality during in situ placement; the impact tape characteristics have on those mechanisms; possible routes to remedy quality defects; and requirements for placement-grade tapes and tows. Heat transfer, intimate contact, interply healing, and intraply void reduction are modeled, tested, and quantified. The causes of inadequate intraply and interply void content reduction are tied to process, material, and head parameters. For the first time, the interaction of intraply voids with conformable compactor forces is elucidated. The interaction of plies coming into intimate contact is detailed. The reason why thermoplastic in situ placement cannot place today's impregnated tapes into autoclave-quality laminates is made clear. This paper defines the materials company challenge to develop placement-grade materials, and for sponsoring agencies to fund material development along with placement development.

## **1. INTRODUCTION**

### **1.1 Thermoplastic In Situ Process, Equipment, and Properties**

Accudyne has developed and patented a thermoplastic tape and tow placement head, process, and process control system for fabricating composite laminates without an autoclave [1-4]. The head places one 75 mm prepreg tape (Figure 1.1-1) or twelve 6.35 mm tows. It features multiple heating sources with cascaded torches to preheat the laminate to 430 °C. Four active conformable compactors consisting of a heated line and area, followed by a chilled line and area provide the normal compaction force cascade to consolidate the molten tape with a 581 kg total load capacity. The compactors are conformable to 10:1 slopes with a 12 mm height [5-7].

The head consistently fabricates laminates that achieve 89 - 97 % of various strengths measured from autoclaved laminates, as shown in Figure 1.1-2. If the strengths generated by thermoplastic in situ consolidation increased to levels measured from post-autoclave cured laminates, the most significant barrier blocking thermoplastic process and equipment adoption would vanish. Achieving the last 10% of property translation is elusive [8, 9, 20], so building on University of Delaware modeling [10-18], the team sought to fully model and validate the process to identify the important physical and material mechanisms controlling microstructure and properties [19]. In addition, the team described the laminate microstructure resulting from placing current tapes, considered head modifications to improve quality, and suggested a specification for placement-grade tape [9, 20].

## 1.2 Baseline APC-2/AS-4 Laminate

A baseline  $[0]_{20}$  laminate was placed from commercial APC-2 AS-4 prepreg tape (Figure 1.2-1) using Accudyne's standard setpoints (Table 1.2-1) and closed-loop machine control. The tape has excessive void content, in spots up to 21 % or more. Thickness variation and roughness are considerable as well. The tape has one resin-rich side and uneven fiber/resin distribution across the width. The head must reform the tape into a perfect flat shape, eliminate the intraply voids, create 100 % ply-to-ply intimate contact without generating interface voids, and heal the mating surfaces to generate perfect thermoplastic welds.

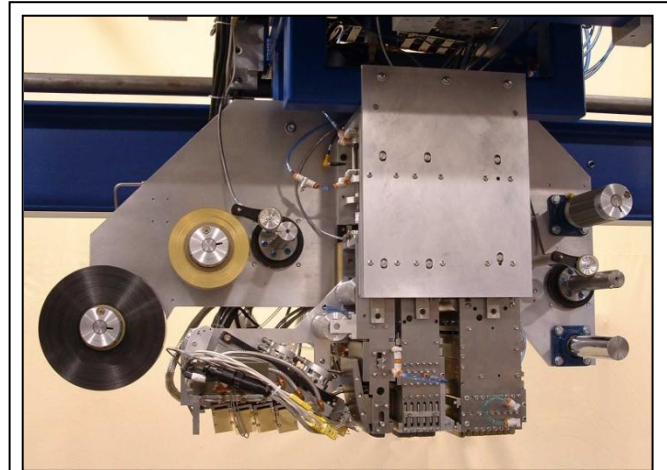

Figure 1.1-1 The Accudyne thermoplastic in situ consolidation tape deposition head on the NASA-LaRC gantry.

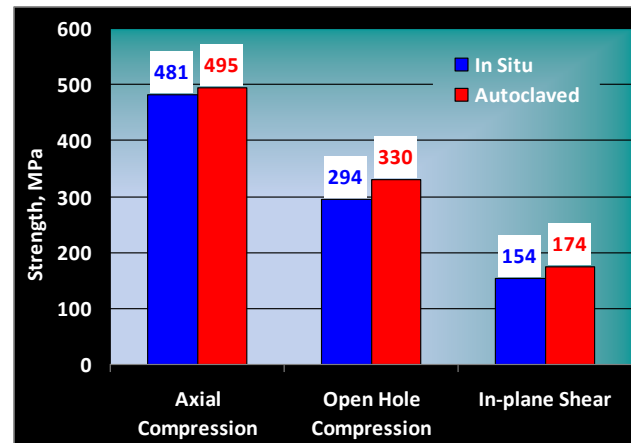

Figure 1.1-2 APC-2/AS-4 laminate strengths resulting from the in situ consolidation and autoclave process. 89 - 97 % of autoclave strengths are consistently achieved. [19]

Table 1.2-1 Standard setpoints used for laminate placement with the Accudyne head

Main and mini gas temperature setpoints	400 °C/430 °C
Heated Line Area/Chilled Line Area load setpoints	82 kg/136 kg/227 kg/136 kg
Placement Speed	1.83 mpm (6 fpm)

The laminate photomicrograph (Figure 1.2-2) reveals microstructure typically achieved with APC-2 AS-4 commercial tape, Summary comments regarding the microstructure are:

1. The intraply voids throughout the laminate reflect those in the incoming APC-2 AS-4 tape. The voids in place are the same size and same shape in the laminate as in the tape.

2. Interply voids are found between some layers. Tape thickness variability is partly responsible. Also, resin pockets between fiber-rich areas leads to uneven transverse loading during compaction, preventing void elimination. Fiber-rich stacks act like columns surrounding resin pockets and resist the transverse load so pressure is not applied to the resin or voids, preventing resin flow and displacement.
3. The fiber/resin distribution is uneven with three main features: Firstly, there is a beneficial resin-rich surface on each layer that assists in forming excellent layer-to-layer welds, uncommon in competitor tapes. Secondly, the fiber/resin distribution manifests a brick-wall-like appearance in the layers, as fiber tows group alternately together and then apart, leaving pockets that can manifest into intraply voids. Thirdly, the fibers assemble into closely-packed arrays around some voids, eliminating routes for void escape or for resin to fill the void.
4. The unidirectional layers nest as the fibers are collinear, improving layer-to-layer intimate contact and consolidation over that commonly observed in [0/90] or [0/45/90/-45] laminates.
5. Intimate contact is not fully achieved with APC-2 tape. The exposed top surface is jagged from residual tape thickness variation after placement. This surface reveals the roughness that would have greeted each ply. For 100 % layer welds, 100 % intimate contact is required before molecular closeness and full healing can result. This was never achieved with APC-2.

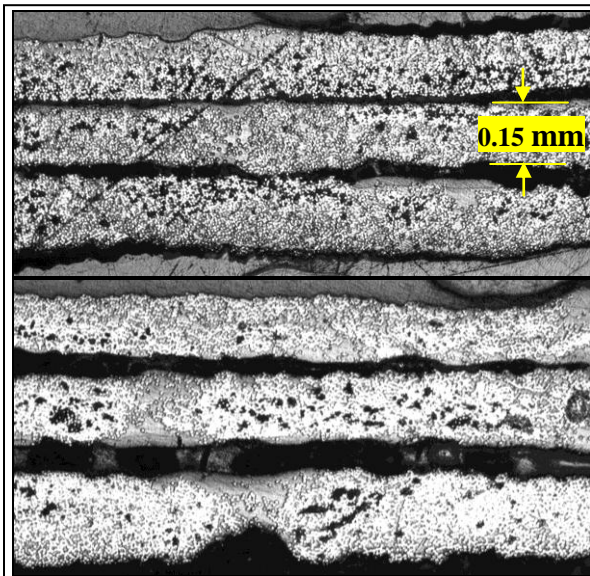

*Figure 1.2-1 APC-2 AS-4 tapes show excessive tape roughness and void content.*

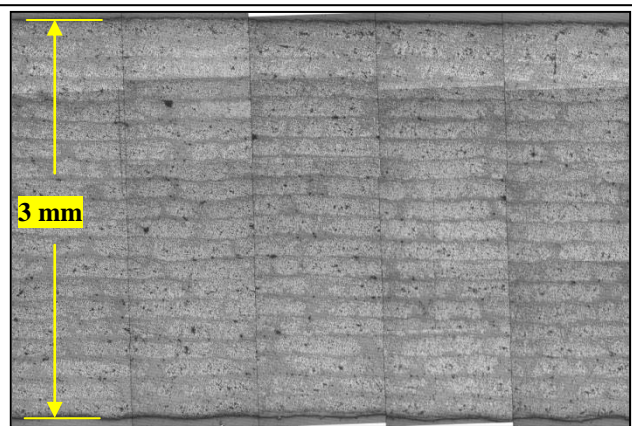

*Figure 1.2-2 APC-2/AS-4 laminate placed at 430 °C and 1.83 mpm. The tape intraply voids are not fully eliminated. Interply voids develop where tape thickness variation was excessive in combination with resin-rich areas. Tape residual roughness prevents intimate contact. Thickness is 3 mm (typical)*

## 2. TECHNICAL PROGRAM

### 2.1 Placement Experiments with Various Materials, Processes, and Head Configurations

Accudyne evaluated process, material, and deposition head changes to remedy laminate microstructure. A brief description of these studies is presented in the following section.

Effect of Heating Temperature – Increasing processing temperature yielded improved microstructure by lowering resin viscosity during placement – generating intimate contact, fostering void elimination by easing resin flow, and promoting interply healing, just as predicted

and simulated by process and quality modeling [19, 20]. In addition, heating to depth is improved and the head achieves temperatures above  $T_g$  many layers down; heating to depth increases with increases in placement temperature. Noting resin degradation limits, we selected 430 °C as the highest temperature setpoint.

Effect of Chilling Temperature – Increasing chilled line and area compactor chilling effectiveness by decreasing setpoint temperature from -2 °C to a -13.6 °C controlled void rebound following head departure from the process spot. Microstructure improved with fewer voids. This fortuitous result is tempered by noting that rebounding voids indicate re-expansion of captured high-pressure gases arising from evaporating entrapped volatiles.

Effect of Compaction Pressure – Low and high force motifs were evaluated, including some where initially lower loads were applied, potentially to allow volatile gases to escape. In the end, processing with the highest applied compaction forces yielded the best microstructure, replicating intimate contact development and void elimination theory. Force limits are defined by conformable compactor shim tearing and gantry force limits; Accudyne’s is 581 kg. The best Heated Line Area/Chilled Line Area compactor load motif was: 82 kg/136 kg/227 kg/136 kg.

Effect of Development Tape – Cytec produced experimental APC-2 AS-4 tape (Figure 2.1-1) for evaluation at Accudyne. The tape features uniform thickness, few voids, and a more uniform fiber/resin distribution, but some limitations. Placement experience almost always resulted in a better laminate than when placing commercial APC-2 AS-4 (unidirectional Hexcel AS-4 carbon fiber impregnated with a Cytec-defined PEEK formulation: [www.cytec.com](http://www.cytec.com)). Figure 2.1-2 shows laminates from commercial and experimental APC-2 AS-4 tapes.

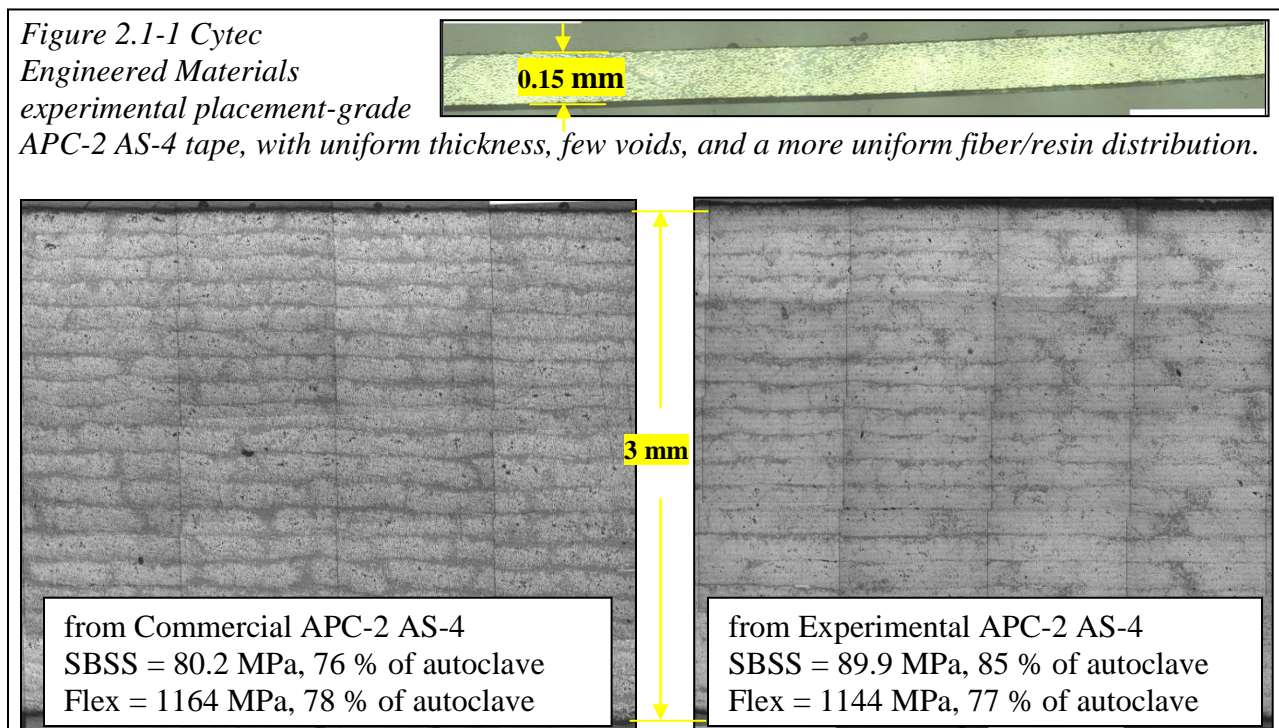

Effect of Post Processing – Accudyne experience with vacuum bag reprocessing has been mixed. Vacuum bag/oven and autoclave reprocessing usually, but not always, improved the quality of in situ placed laminates, depending upon the degree of entrapped volatiles. For example, Figure 2.1-3 shows remaining intraply void content following vacuum bag reprocessing.

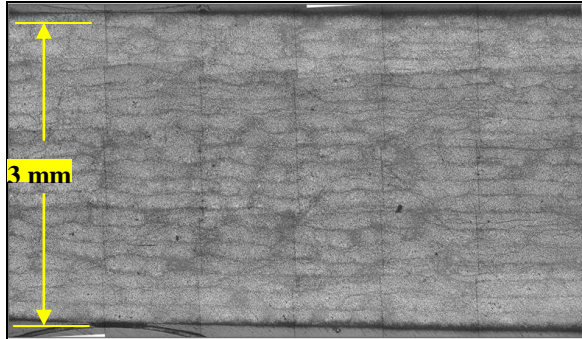

*Figure 2.1-3 An APC-2 AS-4 in situ placed laminate reprocessed with vacuum bag/oven conditions is an example of the challenge to regenerate quality microstructure with that post process. In this laminate, intraply voids are visible, especially in the lower layers. Almost all the voids appear within the layers and have the same characteristics as those in the incoming tape. (Thickness is 3 mm)*

Effect of Autoclaved Tape – The team prepared autoclaved APC-2 AS-4 tape, and then precut 75 mm strips, placing them into a  $[0]_{20}$  laminate using standard process conditions (Table 1.2-1). Interply welds were perfect but some intraply voids remained. The laminate SBSS exceeded 111 MPa (105 % AC) with 1341 MPa flexural strength (90 % AC); high values. A limitation of this experimental fabrication technique is that full crystallinity had developed in the pre-autoclaved tape, and some highly crystalline layers would not have fully melted to allow flow into voids.

Effect of Speed – Laminate quality modeling (presented in Section 3) indicated a process velocity limit of 0.03 to 0.15 mpm for commercial APC-2 AS-4; too slow for commercial use. Laminates placed from a number of tapes bore this out. Figure 2.1-4 shows quality improvements as placement speeds slow from 1.83 mpm to 0.3 mpm to 0.15 mpm.

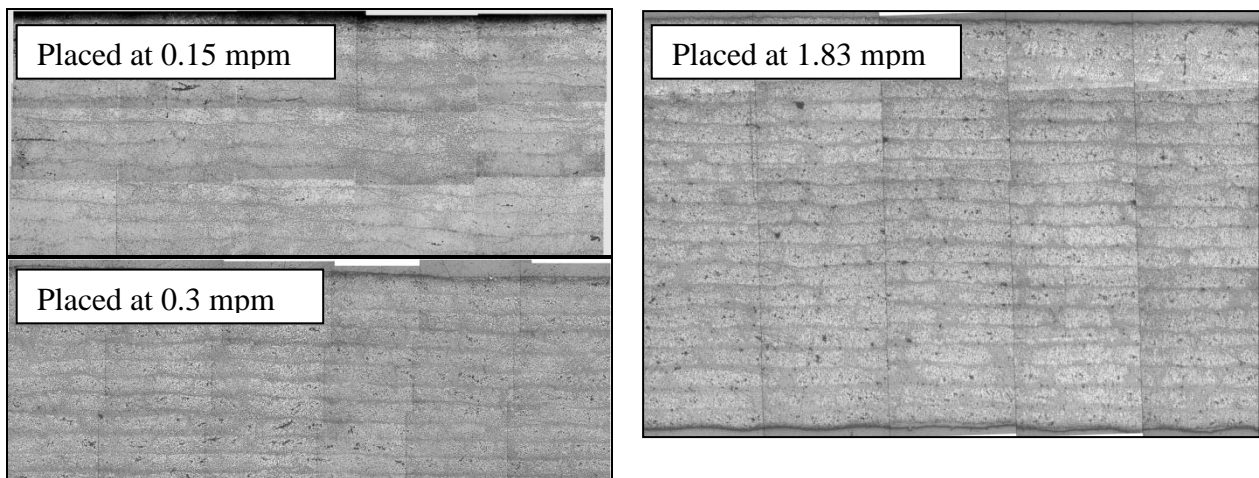

*Figure 2.1-4 APC-2 AS-4 laminates have a modeled speed limit of about 0.03 to 0.15 mpm for void elimination. Experimental laminates placed at similar speed indicate that slower yields higher quality.*

Effect of Alternate Tape Supplier or Alternate Matrix Resin – Accudyne placed a large number of laminates from “Supplier A” and “Supplier B” PEEK and PPS tapes at various speeds, process

conditions, and head configurations. These two suppliers asked not to be named. The laminates were almost all worse quality than those placed from commercial APC-2 AS-4. Characteristically, the tapes appear far more uniform than APC-2 AS-4 with lower thickness variation and fewer voids (Figure 2.1-5). However, both are made from different impregnation processes as they are devoid of surface resin. Thus, laminates made from these composite tapes have interply voids in significant numbers. An example is shown for “Supplier A” PEEK AS-4 in Figure 2.1-6. Accudyne posits that tapes for in situ processing must have a resin rich surface.

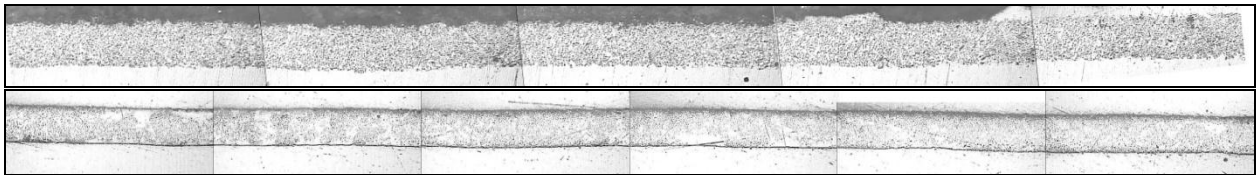

Figure 2.1-5 “Supplier A” PPS AS-4 tape and “Supplier B” PEEK carbon tape

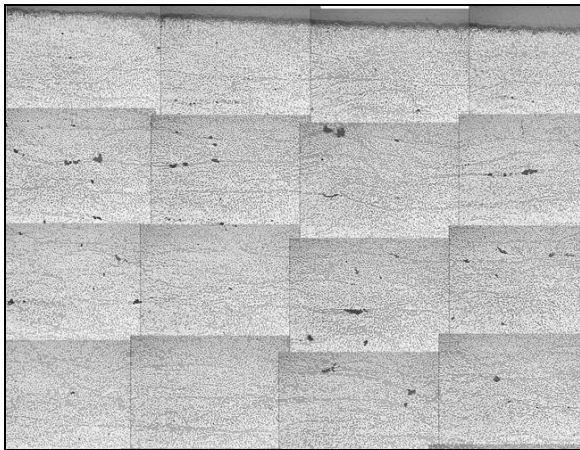

Figure 2.1-6 “Supplier A” PEEK AS-4 was used to fabricate a large number of laminates on the Accudyne head. In addition, PPS and “Supplier B” laminates were fabricated. “Supplier A” and “Supplier B” tapes share the characteristic of lacking surface resin on the tapes; tape surface resin is required to facilitate full healing and bond development in the presence of ply thickness variation. This fatal flaw prevents adequate weld development in the in situ placed laminate and microstructure always shows significant interply voids.

Alternate Head Configurations - Accudyne evaluated several alternative compactor configurations. Modifications included decreasing compactor contact radii to increase local pressure at the expense of compactor length, or adding extended compactor lengths, or both. There were minor/no improvements in laminate quality over laminates from the incumbent head. This result is consistent with simulations teaching that the overall force level is more influential than how locally it is applied [19]. A parametric study revealed no head modifications that could remedy the quality gap with the current impregnated tapes unless compactor force levels climb significantly. University of Delaware completed an initial evaluation by adding on-head vibration components to aide compaction with some early success; much development remains.

### 3. MODELING/MEASUREMENT PROGRAM

#### 3.1 Modeling/Validation for the Accudyne Head and Process

##### 3.1.1 Heat Transfer

To determine the causes of the quality gap to laminates that are autoclave processed, the heat transfer effectiveness must be understood. The three most important questions are:

1. What is the temperature response to the heat source and compactor heating and chilling?

2. How deep the heat diffuses into the laminate and its temperature distribution  $T(x, y, z, t)$ ?
3. What is the laminate temperature history following the head contact so as to monitor deconsolidation?

In Reference 19, the team demonstrated a simulation showing the heating effectiveness was significant and extended throughout the sixteen ply laminate depth so that even the plies near the tool achieved  $T_g$ . However, that simulation was a response to a controlled surface temperature measured from 1.83 mpm placement, and could not be extended to other placement speeds. The team endeavored to demonstrate a more advanced simulation to understand heat transfer.

An ANSYS Multiphysics model was prepared (Figure 3.1.1-1) to simulate the influence of the heating and chilling sources on the laminate and tooling. The model captures the combustion energy from each torch, the heated line and area compactor heating, and the boundary conditions of the chilled line and area compactor chilling. The simulation tracks the laminate and tooling transient temperatures in 3D throughout the process.

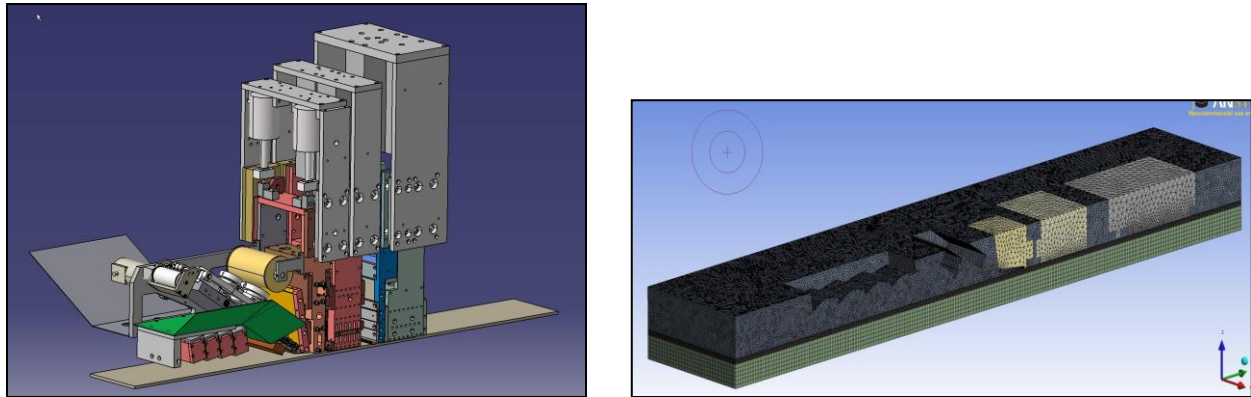

Figure 3.1.1-1 The ANSYS Multiphysics model for the Accudyne head heat transfer.

The thermal response of the laminate is shown in Figure 3.1.1-2. The torch heat transfer was validated with a thermocouple map as a function of flow and distance away. The surface temperature predictions were validated with thermocouples embedded in the laminate as shown in Figure 3.1.1-3. Comparing the two temperature response maps shows agreement at the heating and chilling ends of the simulation, but a dead zone in the ANSYS simulation between the mini-gas torch and the heated compactors.

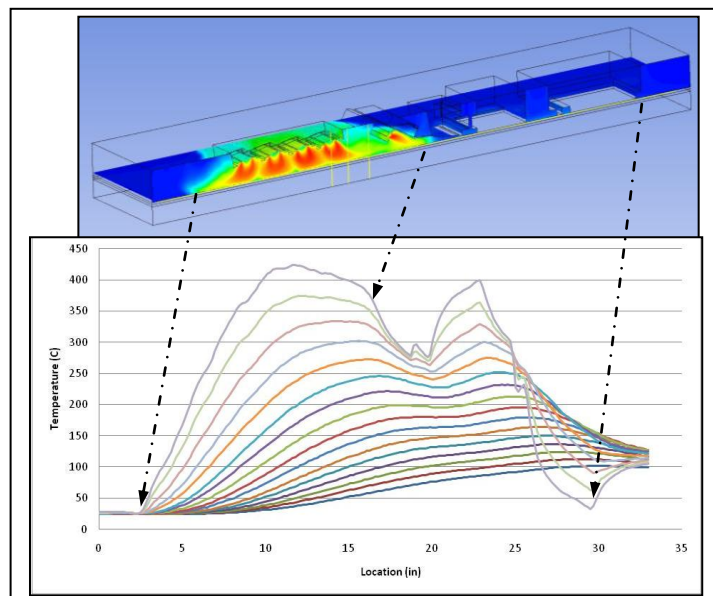

Figure 3.1.1-2 ANSYS Multiphysics model process. The top three layers melt during placement; the top eleven reach  $T_g$ . The entire laminate warms from laminate preheat energy storage; the surface temperature rebounds after placement from beneath 50 °C to above 100 °C.

The simulation shows that the top ply 16, the second ply 15, and the third ply 14 all melt during the surface placement. Plies 16 down to 6 all exceed  $T_g$  during placement. Overall, the laminate becomes ever warmer and the head's ability to extract the stored energy is limited; void rebound is a threat with in situ placement.

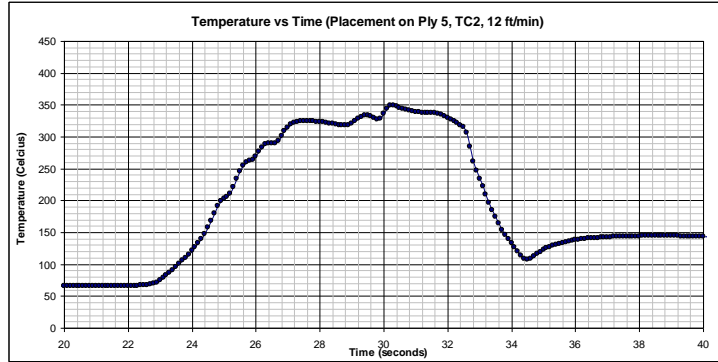

Figure 3.1.1-3 Measured temperature history for the Accudyne thermoplastic head placing at 1.83 mpm. The thermocouple has been embedded one ply down in the unidirectional laminate.

### 3.1.2 Intimate Contact

The team created an initial intimate contact model in Phase 1 [19]. Two difficulties were 1) the model was not validated, and 2) the rough surface, like that shown in Figure 3.1.2-1 for APC-2 AS-4 composite tape, could not be described by the several geometric parameters that make up the roughness coefficient  $R_c$ , a ratio of various surface asperity parameters [6, 13-14, 19-22].

In Phase 2, University of Delaware used the Polyflow simulation package (Figure 3.1.2-2) to capture the exact geometry of the APC-2 AS-4 tape surface. The squeeze flow predicted by Polyflow experienced dramatic deformations at the surface, so remeshing was necessary every ten iterations for convergence.

Figure 3.1.2-3 shows the local shear rate after 0.7 and 70 seconds. The contact between the viscous fiber/resin composite and the upper surface increases. Monitoring this contact throughout the process allows a comparison with the solution developed in Phase 1. Surprisingly, selecting  $R_c = 0.29$  is too generous (smooth). A more realistic APC-2 AS-4 roughness estimate is between 0.168 and 0.22 (lower numbers indicate more roughness).

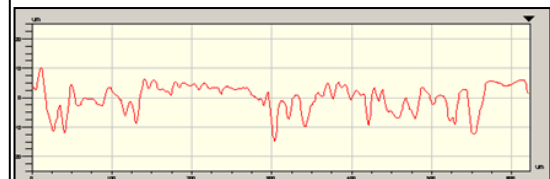
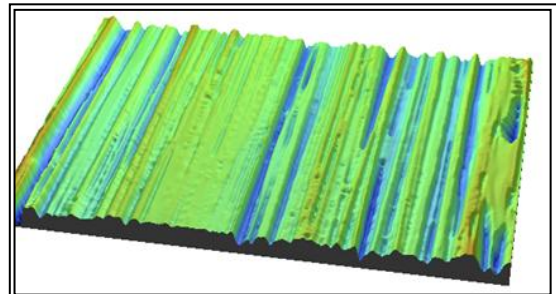

Figure 3.1.2-1 Metrology showed significant surface roughness on APC-2 tapes and finished laminates.

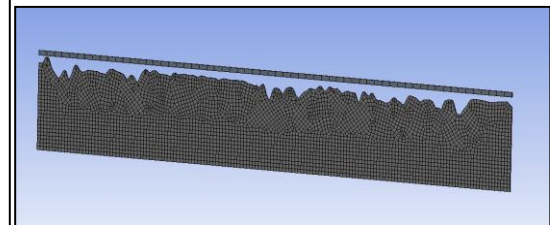

Figure 3.1.2-2 Polyflow mesh of the tape roughness

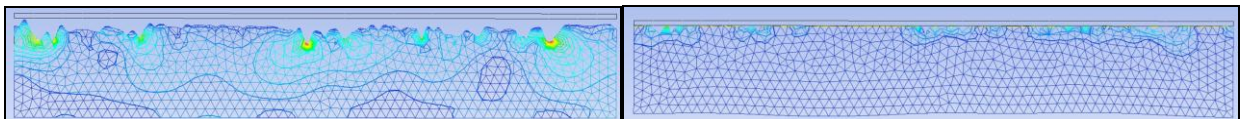

Figure 3.1.2-3 Local shearing rate at 0.7 s and 70 s for the Polyflow squeeze flow solution shows the increase in contact from early times to very long times between actual tape profiles.



Figure 3.2.1-4 shows the results for this particular profile show an  $R_c = 0.168$  surface roughness matches well with the FE solution. Also note that the intimate contact model assumes a uniform array in contact with the surface that results in fast intimate contact development early in the process. The Polyflow FE solution shows a more gradual development of intimate contact based on the actual surface roughness.

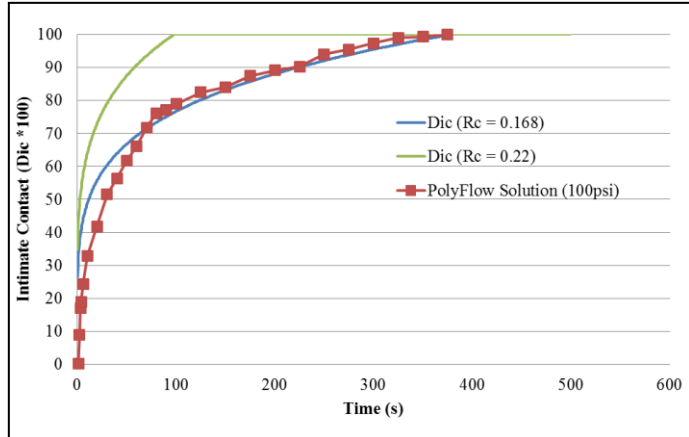

Figure 3.2.1-4 Polyflow FE solution for intimate contact development compared with standard IC model for 100 psi applied pressure. The best estimate for  $R_c$  is 0.168.

### 3.1.3 Intraply Voids

The Phase 1 solution for tracking the evolution of void content [19] is via the void compression mechanism. This model motivated better chilled compactor development but its predictions did not sufficiently match with intraply void distribution experience in actual laminates. Typically, APC-2 AS-4 laminates can be placed with 1 % to 2 % voids even though the tape arrives with 10 % to 20 % voids. The void compression simulation predicted a modest decrease. In addition, there was no route for voids to escape with the compression simulation. In this Phase, University of Delaware developed a simulation that combines void filling, flow through a fiber bed, void compression, and void escape.

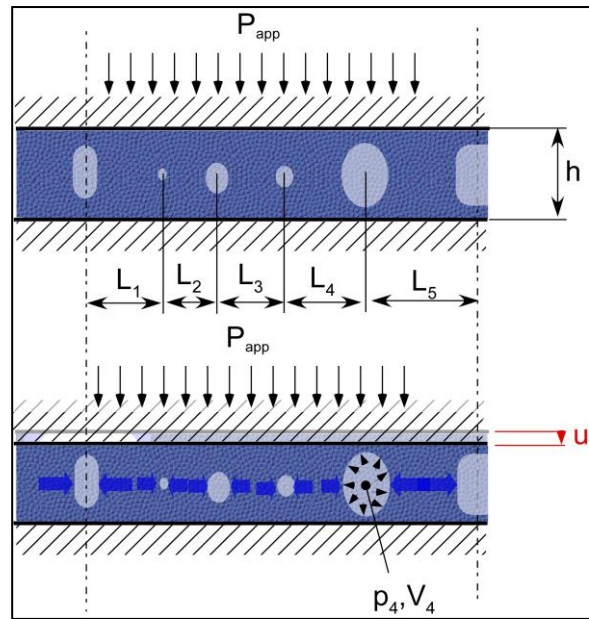

Figure 3.1.3-1: Void distribution and its model description. The voids are spaced unevenly and can be a variety of sizes.

The resulting model is described in Figure 3.1.3-1. The plies are described individually and are loaded by the applied normal pressure. The voids can be large or small and exist with an initial void volume and pressure. The voids can be a vacuum, can be filled with a gas, or can be a cavernous fiber bed with a defined permeability. The voids are spaced from one another by a length  $L_1, L_2, \dots, L_n$ . By far, the most interesting results accrue when the simulation is run with voids of different sizes and spacings.

A second interesting phenomenon was revealed by this study. Following compaction, the resin flow into a cavernous void depletes the tape of its local resin supply and no further flow can result. Figure 3.1.3-2 shows fiber rich areas within a tape where further flow in is impossible. Figure 3.1.3-3 shows the fibers hexagonally close-pack and lock up the voids. Clearly, a new parameter that becomes important for the simulation is the layer permeability.

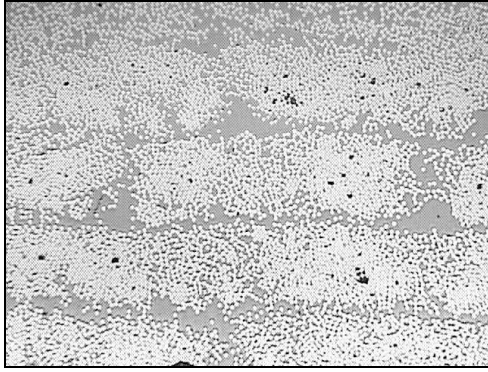

Figure 3.1.3-2 Fiber rich areas within a tape prevent further flow into voids.

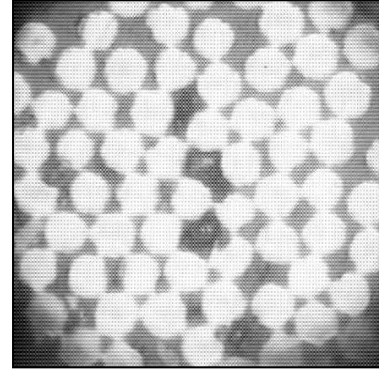
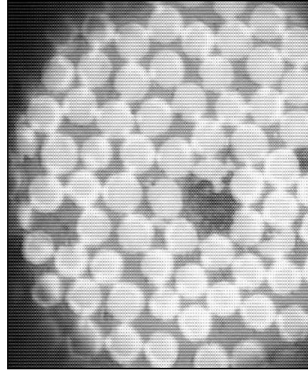

Figure 3.1.3-3 Fibers hexagonally close-pack and lock up the voids.

Two simulations are shown below. The first, in Figure 3.1.3-4, is for a representative laminate with five voids at four spacings, inspired by voids found in actual tape. The resin pressure development is tracked while the tape is under 1 MPa applied transverse pressure for 10 s at 377 °C. The ordinate lists the pressure resisting the applied load. At 0 s, the pressure is zero at the voids, and rises where the transverse modulus is highest, that is, where the tape is fiber rich and support load between the voids. Resin under high pressure flows to fill the voids at low pressure, whether the void is a bubble or has a permeable fiber bed. At 2 s, the 4<sup>th</sup> void (from left) is filled and the pressure rises there. At 4 s, the 3<sup>rd</sup> void is filled and the pressure rises there as well. However, the pressure for some voids (Void 1 and 2) remains low at 0 s, 2 s, 4 s, 6 s, and 9 s. These voids never get compressed, regardless of pressure application time, because the applied pressure goes to supply the resin flow rather than to compress the void itself. **Process engineers think the head compacts the voids; it is doing nothing of the sort.** The pressure is never applied to large voids that are nearby other large voids.

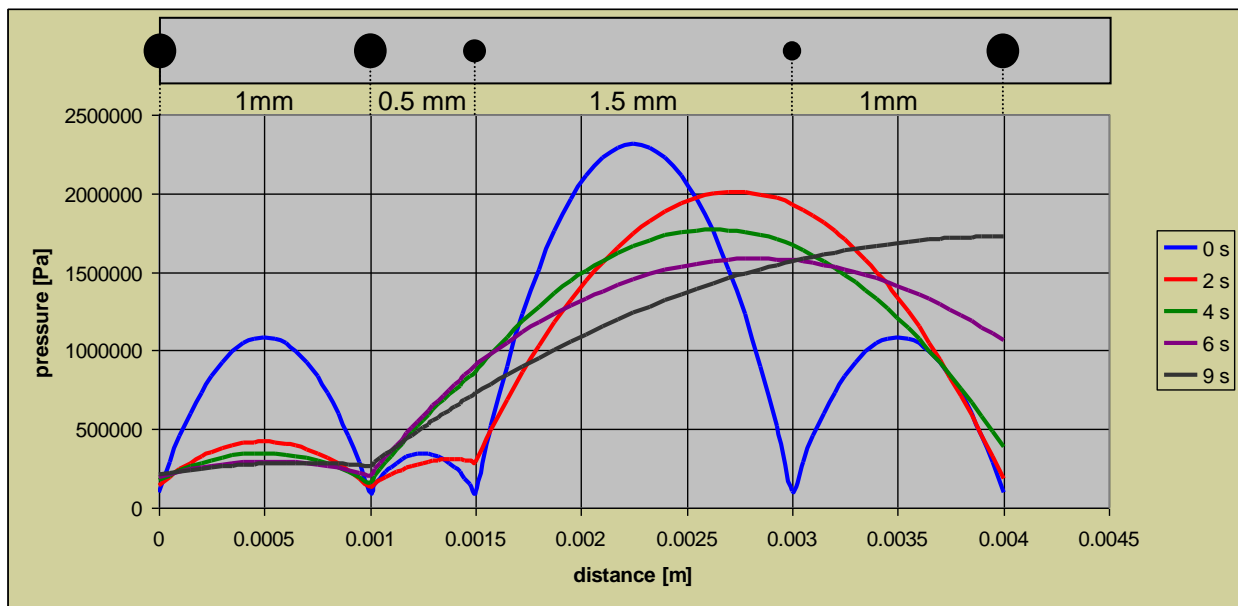

Figure 3.1.3-4 Void filling simulation for a laminate containing five voids at four spacings. Tape internal pressure is defined for 0, 2, 4, 6, and 9 second placement.

Another way to describe this phenomenon is to observe that there is no ‘following force’ as with a flexible vacuum bag under hydrostatic autoclave pressure. The laminate is not under force control. Instead, the conformable compactor segment width is about eight tape thicknesses, and thus exceeds the local area of any void; the pressure application on any local void is by displacement control and the composite/void system is statically indeterminate. The fiber-rich areas, not the voids, provide the greatest resistance to thickness reduction/consolidation and limit the extent of void reduction possible at these placement velocities.

While the voids adjacent to long resin rich segments get reduced initially, the filling rate of the other voids is effectively small until the former are fully compacted. Two larger voids close together will never be filled, no matter the time the head places. The only possible solutions would be to 1) provide a conformable compactor that would work in force control, 2) eliminate the tape voids, or 3) agitate the tape to redistribute or remove voids by another mechanism.

Figure 3.1.3-5 shows a real APC-2 AS-4 tape, with the void fraction displayed at various times after placement up to 8.71 s. In this case, image analysis software created by the University of Delaware was used to map the void distribution along the tape. Initially, the 10 % void content is rapidly reduced to 8.7 % as widely-spaced voids are reduced in size. However, shortly after the resin fills some voids, the large voids are not under pressure, and resin flow, fiber motion, and void reduction grinds to a halt. Note that Figure 3.1.3-5 matches our placement experience on hundreds of laminates.

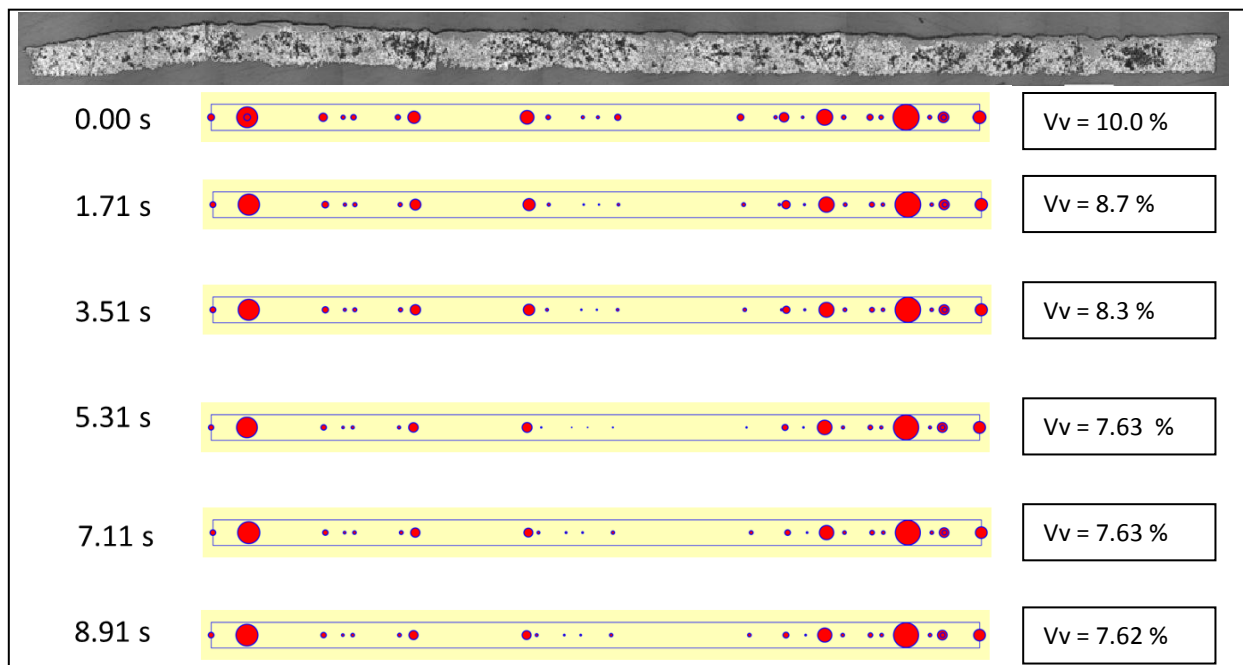

Figure 3.1.3-5 The void model tracks the motion and filling of voids with different sizes and different spacings. Where there are widely spaced voids in fiber/resin rich areas, the void volume is filled and decreases. However, neighboring large voids are never filled.

The cause of limited void reduction is the same (Figure 3.1.3-6). The applied pressure is by displacement control and the large voids are never compacted. While widely-spaced voids benefit from a large resin supply, closely spaced voids deplete the local resin supply and cannot oppose the applied compactor force.

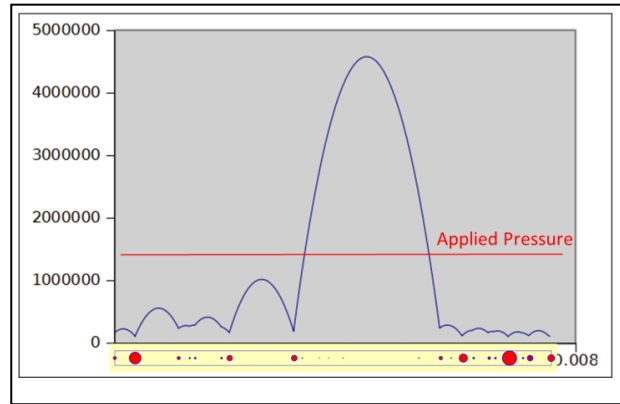

Figure 3.1.3-6. The applied pressure is by displacement control and the large voids are never compacted.

### 3.2 Quality Simulations

The team generated and used a single ply quality model to simulate the impact of constant compactor inputs or an entire head pressure/temperature profile on void content reduction, generation of intimate contact, and healing between plies. Figure 3.2-1 shows the quality model front screen when running in profile input mode. Inputs on another screen describe the placement parameters, material inputs and viscosity settings, and initial conditions like Rc for intimate contact and void volume. Here, the actual applied pressure from the compactors is in blue and the temperature from the head's eight heat sources is in red. The output void volume, intimate contact, and healing vs. time is shown in blue, green, and red, respectively, on the right screen. A large number of parametric studies were conducted using this simulation.

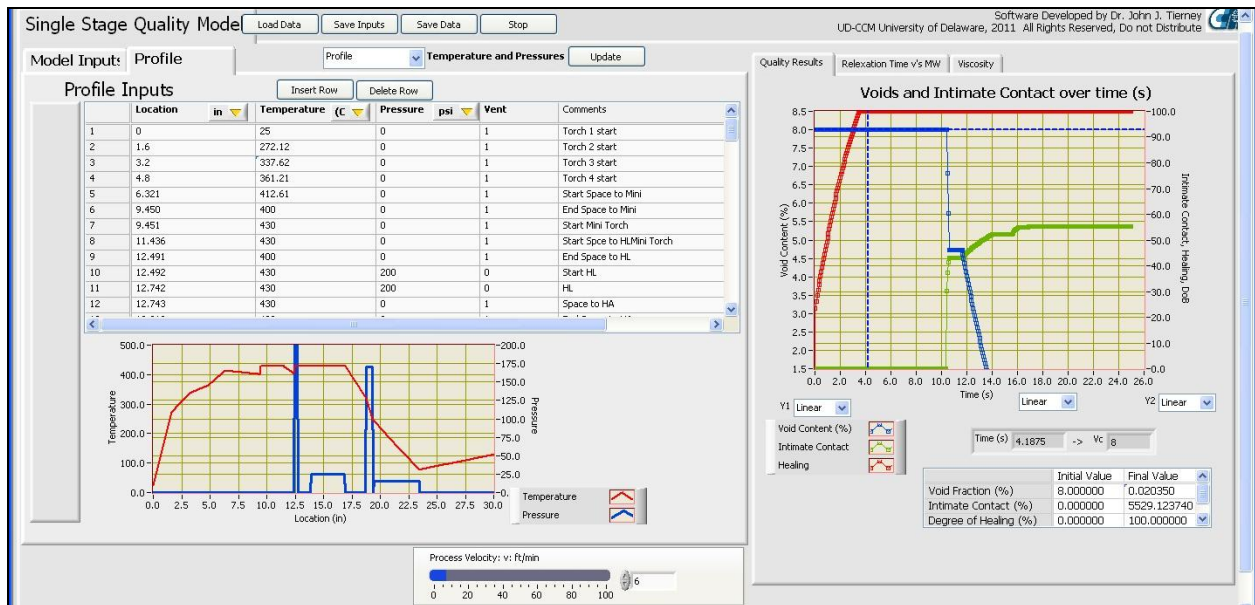

Figure 3.2-1 A single ply quality calculator determines void volume, intimate contact, and healing during the process as a function of actual head inputs and material characteristics.

When a large number of runs are completed, they can all be assembled on one graph to define the times required for completion of some physical mechanism. This also allows for the definition of a characteristic time, valid for a tape and a process.

Figure 3.2-2 shows the development of interply healing while placing at various speeds covering five orders of magnitude. The healing curves form a cascade. Full healing, assuming full intimate contact, is achieved in 0.1 seconds.

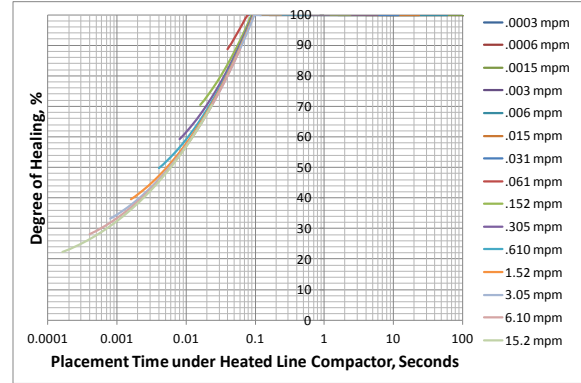

Figure 3.2-2 Healing cascade

Figure 3.2-3 shows the development of intimate contact while placing at speeds covering the same five orders of magnitude. Again, the intimate contact curves overlap in a cascade. They show that full intimate contact is achieved at 10 seconds of placement time.

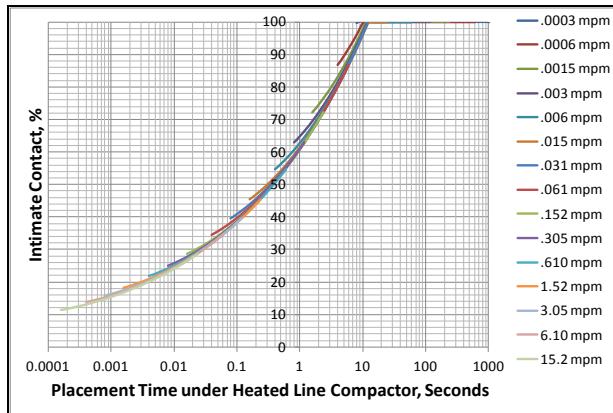

Figure 3.2-3 Intimate contact cascade.

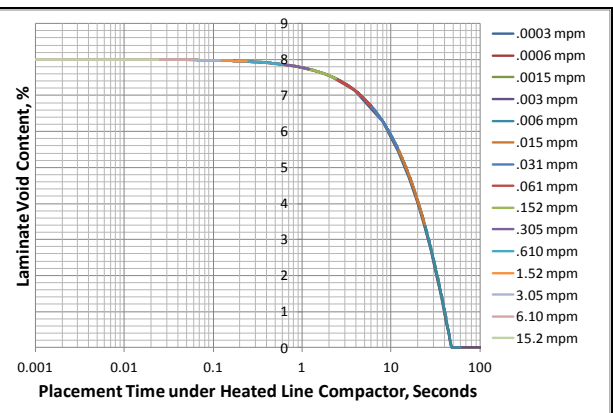

Figure 3.2-4 Void volume cascade.

## 4. CONCLUSIONS

1. With today's thermoplastic tapes, the in situ consolidation process does not produce autoclave quality laminates because of insufficient time at temperatures and pressures needed to successfully consolidate and bond the composite tapes in their current form. As a result, improvements to the tape are required so that acceptable quality laminates can be fabricated with this transient process.
2. Process developers have long hoped to apply pressure to the thermoplastic tapes during processing to reduce the voids. This is not achieved. The pressure is resisted by fiber-rich resin areas and the voids are not compressed. This is in-principle a show stopper for thermoplastic in situ automated tape placement, and must be addressed by further material development by the composite tape suppliers.
3. Composite tapes lacking surface resin were not placed into quality laminates. After hundreds of laminates, there is doubt that tapes lacking surface resin could generate full layer-to-layer weld strength.
4. Composite tapes with adequate surface resin had excessive thickness variation and roughness parameters are worse than originally published. Full intimate contact likely will not occur.

5. The characteristic times for developing quality in laminates can be quantified. For the Accudyne head and today's materials, the characteristic times are
  - Intimate Contact: 10 s
  - Healing (assuming full intimate contact): 0.1 s
  - Void Volume reduction: 50 s
6. Changing placement speed, temperature, pressure, resin, supplier, and pre-autoclaving the tape were all ineffective in generating autoclave level laminate quality due to the poor incoming tape quality.
7. We were unable to determine any improvement to the Accudyne head by the parametric study and by experiment except by increasing chilling compactor effectiveness. This was installed and works well. We suspect that there is nothing that can be done to the head that is nearly as effective as addressing the raw material microstructure.
8. Improving tape quality increased laminate properties. For example, SBSS from commercial APC-2 AS-4 gave 76 % of the SBSS of an autoclaved laminate; for experimental APC-2 AS-4, 85 %, and for pre-autoclaved APC-2 AS-4, 105 % of autoclaved laminate SBSS.
9. The placement grade tape specification suggested in Reference [9, 20] is still recommended: FAW = 145 g/m<sup>2</sup>, resin weight fraction 35 % ± 1 % with uniform fiber/resin distribution, surface resin content thickness equal to one filament diameter, thickness variation less than 6 % across entire tape width, with variation +0.00 mm, - 0.10 mm, and void content < 1 %.

## 5. REFERENCES

1. M. A. Lamontia, and R. D. Cope, M. B. Gruber, B. J. Waibel, and J. F. Pratte, "Stringer-, Honeycomb Core-, and TiGr-Stiffened Skins, and Ring-Stiffened Cylinders Fabricated from Automated Thermoplastic Fiber Placement and Filament Winding," 23rd SAMPE EUROPE Conference, Paris, 9-11 April, 2002.
2. M. A. Lamontia, S. B. Funck, M. B. Gruber, R. D. Cope, B. J. Waibel, N. M. Gopez, and J. F. Pratte, "Manufacturing Flat and Cylindrical Laminates and Built Up Structure Using Automated Thermoplastic Tape Laying, Fiber Placement, and Filament Winding," 34th ISTC, Baltimore, MD, November 4-7, 2002.
3. M. A. Lamontia, S. B. Funck, M. B. Gruber, R. D. Cope, PhD, B. J. Waibel, N. M. Gopez, "Manufacturing Flat and Cylindrical Laminates and Built Up Structure Using Automated Thermoplastic Tape Laying, Fiber Placement, and Filament Winding," SAMPE Journal, 39, 2, March/April 2003.
4. M. A. Lamontia, M. B. Gruber, S. B. Funck, B. J. Waibel, R. D. Cope, N. M. Gopez, J. F. Pratte, PhD, and N.J. Johnston, PhD, "The Fabrication And Performance of Flat Skin Stringer and Honeycomb Panels Manufactured by a Thermoplastic Automated Tape Placement Process," 24th SAMPE EUROPE Conference, Paris, April 1-3, 2003.
5. M. A. Lamontia, M. B. Gruber, B. J. Waibel, R. D. Cope, and A. Bruce Hulcher, "Conformable Compaction System used in Automated Fiber Placement of Large Composite Aerospace Structures," 23rd SAMPE EUROPE Conference, Paris, 9-11 April, 2002.
6. M. A. Lamontia, et al, "Contoured Tape Laying and Fiber Placement Heads for Automated Fiber Placement of Large Composite Aerospace Structures," 34th ISTC, Baltimore, Md, November 4-7, 2002.

7. M. A. Lamontia, M. B. Gruber, S. B. Funck, B. J. Waibel, R. D. Cope, PhD, and A. Bruce Hulcher, "Developing A Contoured Deposition Head for In Situ Tape Laying and Fiber Placement," 48th SAMPE, Long Beach, Ca, May 11 – 15, 2003.
8. M. A. Lamontia and M. B. Gruber, "Limitations On Mechanical Properties In Thermoplastic Laminates Fabricated By Two Processes: Automated Thermoplastic Tape Placement And Filament Winding," 26th SAMPE EUROPE Conference, Paris, April 5-7, 2005.
9. M.A. Lamontia and M. B. Gruber, "Remaining Developments Required for Commercializing In Situ Thermoplastic ATP," Proceedings of the 2007 SAMPE Conference and Exhibition, Baltimore, MD, June 3, 6, 2007.
10. J. J. Tierney and J. W. Gillespie, Jr., "Modeling of Heat Transfer and Void Dynamics for the Thermoplastic Composite Tow Placement Process", Journal of Composite Materials, Vol. 37 No. 19, 2003.
11. J. J. Tierney, R. F. Eduljee, and J. W. Gillespie Jr., "Material Response During Robotic Tow Placement of Thermoplastic Composites," Proc. of the 11th Annual Advanced Composites Conf., 1995.
12. J. J. Tierney and J. W. Gillespie, Jr., "Modeling of In-Situ Strength Development for the Thermoplastic Composite Tow Placement Process," Journal of Composite Materials, Vol. 40, No 16, 2006.
13. J. J. Tierney, S. Quirico, and J. W. Gillespie, Jr., "Development of Material Quality during the Automated Tow Placement Process," ASC 13th Tech. Conf., Baltimore, MD, 1998.
14. J. J. Tierney, D. Heider, R. C. Don, K. Steiner, and J. W. Gillespie Jr., "Welding of Thermoplastic Composites using the Automated Tow Placement Process: Modeling and Control," Vol. 1, ANTEC'97, 1997.
15. J. J. Tierney and J. W. Gillespie Jr., "Crystallization Kinetics Behavior of PEEK Based Composites Exposed to High Heating and Cooling Rates," Composites Part A: Applied Science and Manufacturing, 35 2004.
16. J. J. Tierney, R. F. Eduljee, J. W. Gillespie. "Residual Stress and Warpage Development during the Automated Tow Placement Process," Proc. 11th Tech. Conf. on Composites, ASC, 1996.
17. J. J. Tierney and J. W. Gillespie, Jr. "Control of Warpage and Residual Stresses during the Automated Tow Placement Process," Proc. of ANTEC' 98, Society of Plastics Engineers, Brookfield, CT, 1998.
18. J. J. Tierney and J. W. Gillespie, Jr. "Control of Warpage and Residual Stresses during the Automated Tow Placement Process," 43rd Int. SAMPE Conf, Vol. 43 No. 1, 1998.
19. M. A. Lamontia, M. B. Gruber, J. J. Tierney, J. W Gillespie, Jr., B. J. Jensen, and R. J. Cano, "Modeling the Accudyne Thermoplastic In Situ ATP Process," 30th International SAMPE Europe Conference, Paris, March 23-25, 2009.
20. M. A. Lamontia, M. B. Gruber, J. J. Tierney, J. W Gillespie, Jr., B. J. Jensen, and R. J. Cano, "In Situ Thermoplastic ATP Needs Flat Tapes and Tows with Few Voids," 30th International SAMPE Europe Conference, Paris, March 23-25, 2009.
21. Lee, W.I., G. S. Springer, "A Model for the Manufacturing Process of Thermoplastic Matrix Composites," J. Composite Materials, Vol. 21, pp. 1017.1987.
22. Mantell, S. C., and G. S. Springer, "Manufacturing Process Models for Thermoplastic Composites," Journal of Composite Materials, Vol.26 (16), pp. 2348-2377, 1992.